



Attention, Risk of, Danger, Warning



High Voltage, Risk of Electric Shock



Double / Reinforced Insulation



NOT Litter



CE Mark

TECHNICAL SPECIFICATION



- **Dimensions** : PC109:96x96, PC107:72x72mm
- **Panel Cut-out** : PC109:91x91, PC107:68x68mm
- **Display** : 4 Digits 7 Segment (PV), 4 digits 7 Segment (SV)
- **Sensor Type** : J,K,S type T/C, Pt100 selectable
- **Measuring Scale** : -100 .. 600 °C, J type T/C, (Inpt=J), -100 .. 1300 °C, K type T/C, (Inpt=k) 0 .. 1750 °C, S type T/C, (Inpt=S) -100 .. 600 °C, Pt100, (Inpt=Pt)



- **Resolution** : ± 1 °C
- **Accuracy** : ± 0.3 % (Over full scale)
- **Timer Accuracy** : ± % 1.5 (of timer set value)
- **Control Form** : ON-OFF or P, PI, PD, PID - selectable
- **Heat Output** : Relay (NO + NC), 250VAC, 2A, Resistive load, (optional SSR)
- **Alarm Output** : Relay (NO + NC), 250VAC, 2A, Resistive load
- **Heat SET** : 0 .. Scale (depends on the selected sensor type) °C
- **Alarm SET** : AL.tY = Abs; 0 .. Scale °C (A.SET)
AL.tY = rel; -100 .. +100 °C (r.Alr)



- **Heat Hysteresis** : 0 .. 50 °C (H.Hys); PID is active if set to 0
- **Alarm Hysteresis** : 1 .. 50 °C (A.Hys)
- **Proportional Band** : 1 .. 130 °C (Pb.C)
- **Integral Time** : 0 .. 30,0 min. (OFF if set to 0)
- **Derivative Time** : 0.. 10,0 min. (OFF if set to 0)
- **Control Period** : 4 .. 200 sec. (Ct)
- **Offset** : -100..+100 °C (oFFS)



- **Cold. Junc. Comp.** : 0 .. 50 °C (T/C)
- **Line Compensation** : 10 Ohm max. (3 wire Pt100)
- **Sensor Failure** : ALARM and OUT outputs are OFF in case of sensor failure, measurement out of range or hardware fails to measure input signal
- **Supply Voltage** : 100..240VAC, 50-60Hz or (only for PC107) 24VDC/AC (isolation voltage: 40VAC max.)



- **Power Consumption** : < 8VA
- **Humidity** : 80% up to 30°C, then linearly decreases to 50% at 50°C (non-condensing)
- **Altitude** : < 2000 m



- **EMC** : EN 61000-6-1, EN 61000-6-3 (Only light industrial environment)
- **Safety** : EN 61010-1; Pollution degree 1, measurement category I, (Only light industrial environment, double/reinforced isolated, non-conductive pollution environment)



- **Protection Class** : IP20; according to EN 60529
- **Operation Temp.** : 0 .. 50 °C
- **Storage Temperature** : -10°C .. 60°C (no icing)
- **Weight** : < 0.5 kg
- **Torque for screwing** : Max. 0.5 N.m

WARNING: if 2 wire Pt100 is used, connect compensation lead to measuring lead:







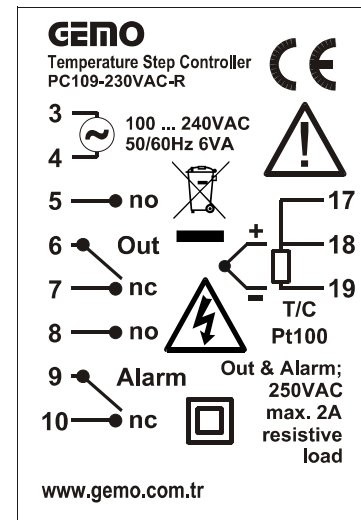
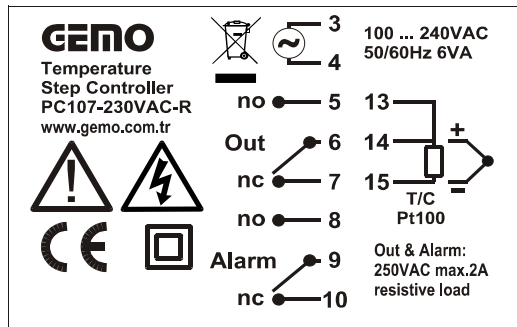















(PC109:17-18, PC107: 13-14)

no: normally open

nc: normally closed



INSTALLATION, USE and WARNINGS

-  ● This device and its packing is NOT litter and may NOT be disposed of with domestic waste. Please return this device and its packing to an appropriate recycling point at the end of its service life.
-  ● Please read this user manual carefully and completely before installation and use. Please take into consideration all warnings mentioned in this manual.
-  ● PC109 / PC107 are suitable only for permanent panel type mounting
-  ● Installation and use of this device must be done by qualified, authorized and trained technical personnel only.
-  ● Inspect device carefully before installation. Do not install and use broken and defective devices.
-  ● Do not disassemble device. Do not make any repair on any part of the device. There is no accessible part inside the device. Please contact to manufacturer for broken and defective devices.
-  ● Do not use device in environments subject to flammable, explosive and corrosive gases and/or substances.
-  ● This device is designed for applications only in light industrial environments. This device is not suitable for medical and residential use. This device is not suitable for use related with human health and safety. This device is not suitable for automotive, military and marine use.
-  ● Do not allow children and unauthorized people to use this device.
-  ● Before installation and any technical work, disconnect the power supply and mains connections.
-  ● Check the power supply voltage level before power on, and make sure voltage level is in specified limits. Check quality of neutral line. Improper neutral line may give permanent damage to the device.
-  ● Connect an external power switch and an external fuse (1A, 250VAC) to the power supply line that are easily accessible for rapid intervention. Connect an external fuse (2A, 250VAC) for each relay output separately.
-  ● Use appropriate cables for power supply and mains connections. Apply safety regulations during installation.
-  ● Install the device in a well ventilated place. Install the device permanently into a proper panel cut-out. Fix the device with two fasteners supplied with the device. Only front panel must be accessible after installation is completed.
-  ● Do not operate the device other then the environmental conditions given in Technical Specification.
-  ● Do not operate the device in environments that may cause conductive pollution.
-  ● Take precautions against negative environmental conditions like humidity, vibration, pollution and high/low temperature during installation.
-  ● Use correct compensation cables for T/C sensors. Connect T/C cable directly to the device connectors.
-  ● Keep device, signal cables and communication cables away from circuit breakers, power cables and devices/cables emitting electrical noise. Use shielded and twisted signal and communication cables and connect shield to earth ground on device side. Keep length of signal and communication cables less than 3m.
-  ● In your applications, always use separate and independent mechanical and/or electromechanical devices/apparatus to support PC109 / PC107 to handle emergency cases.
-  ● Use insulated cable end-sleeves at the end of cables screwed to the device connector terminals.
-  ● Maximum torque for screwing; 0.5 N.m.
-  ● Please check www.gemo.com.tr for latest device and documentation updates regularly. All updates and all information are subject to change without notice.

GENERAL SPECIFICATION

- This device is designed for basic temperature control applications only in light industrial environments.
- μ P based, PID temperature step controller with HEAT and ALARM outputs
- Auto-tuning for PID parameters
- Sensor type: T/C (J,K,S), Pt100, selectable, multi-input
- Selectable control type: P, PI, PD, PID or ON-OFF
- "Anti-windup"
- Maximum 20 steps, selectable
- Maximum 18 hours/step timer setting
- Selectable relative or absolute alarm
- Displays SET, Process, Step no and Remaining time values
- Cold-junction compensation for T/C
- Line compensation for Pt100
- Excellent linearity with $^{\circ}$ C/mV and $^{\circ}$ C/Ohm look-up tables
- Input "Offset" feature
- Password protection
- High accuracy
- EEPROM memory to store settings
- Optional SSR output
- Easy connection with plug-in connectors

PROGRAMMING SYSTEM PARAMETERS

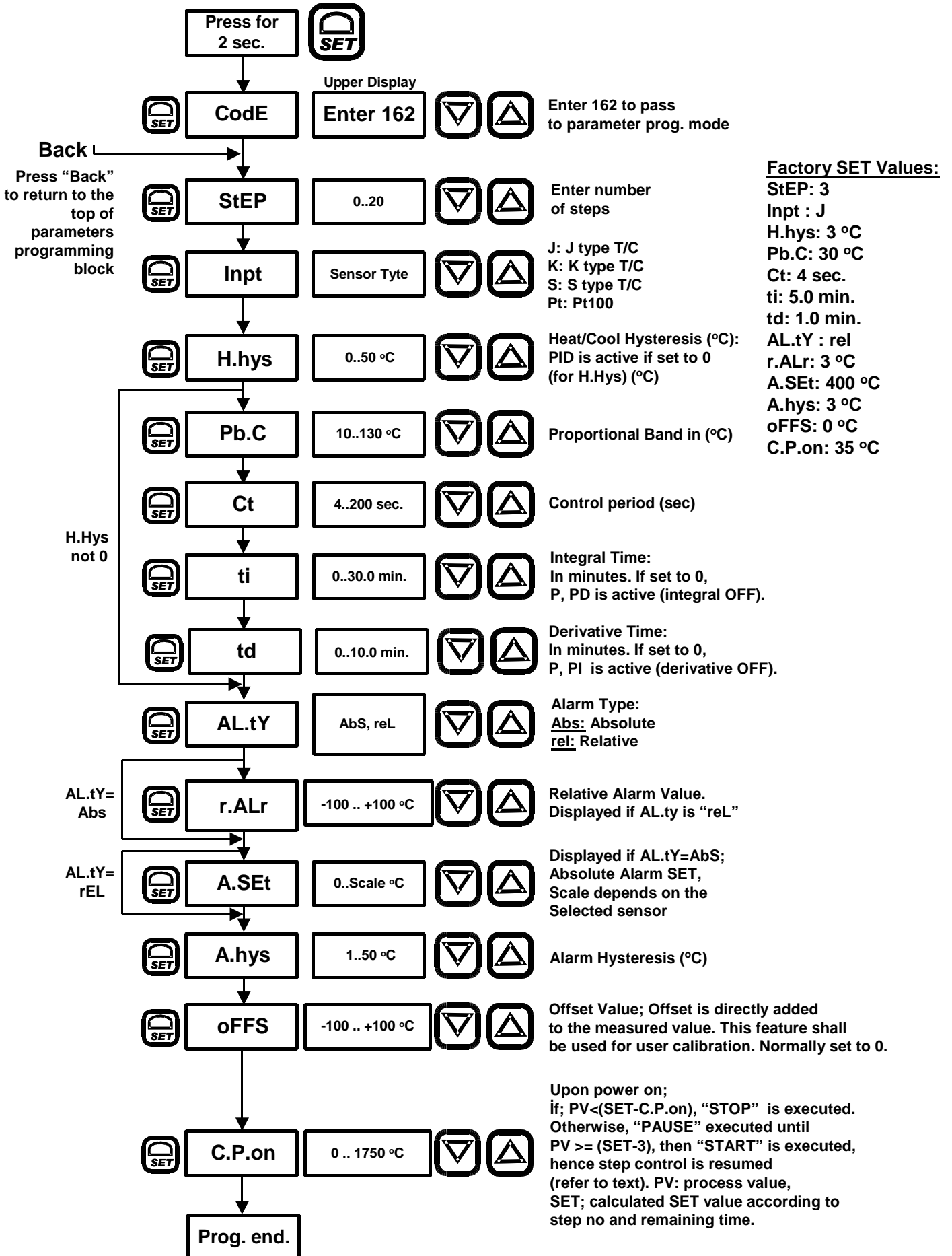

PROGRAMMING STEP HEAT SET VALUES

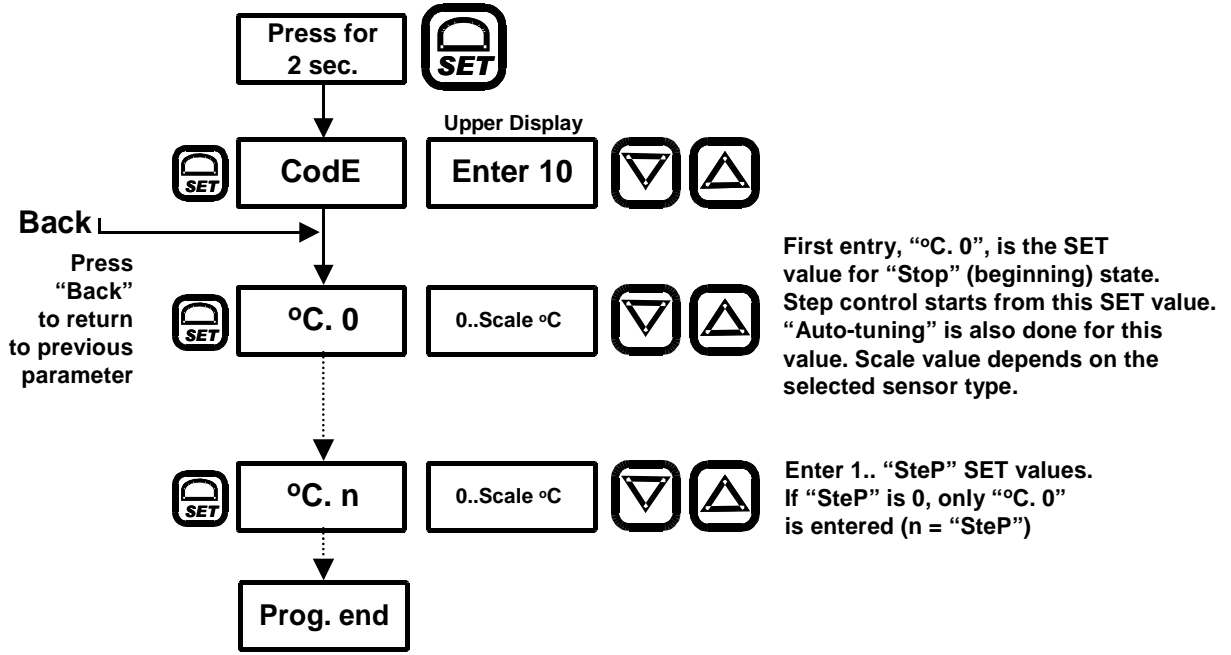

PROGRAMMING STEP TIMER VALUES

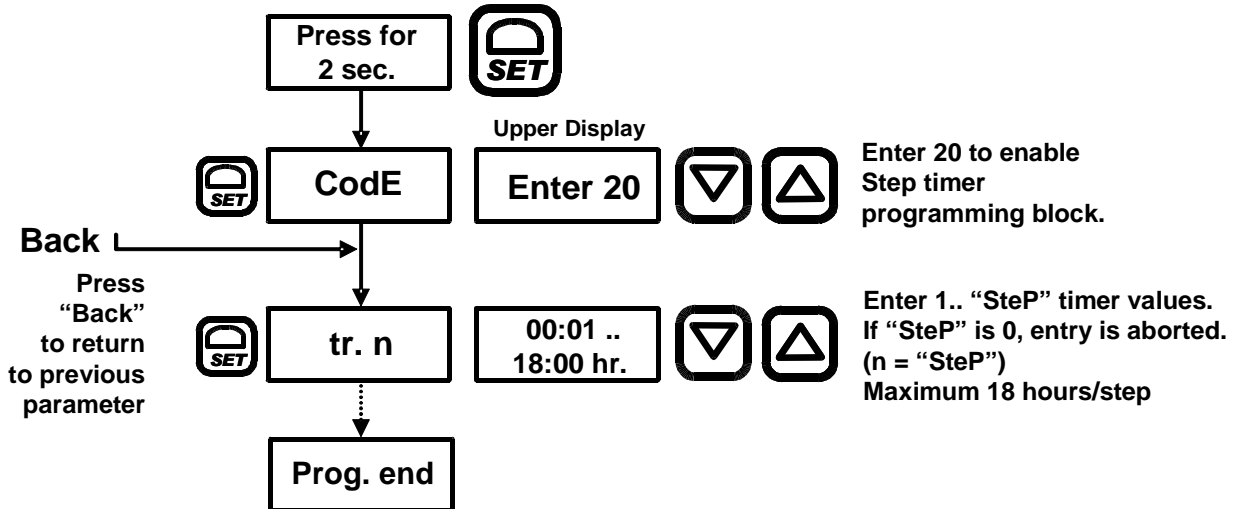

STARTING STEP CONTROL; "START" COMMAND

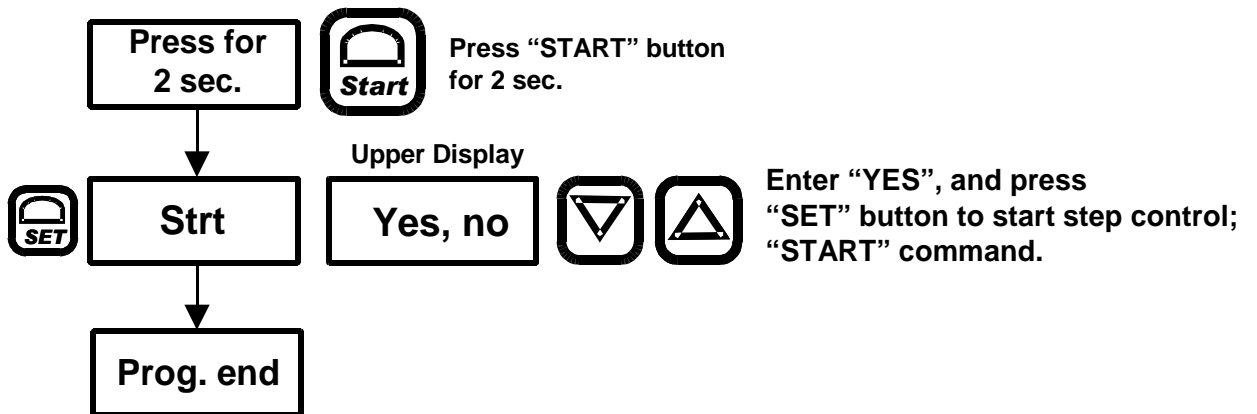

RESETTING (STOPPING) STEP CONTROL; "STOP" COMMAND

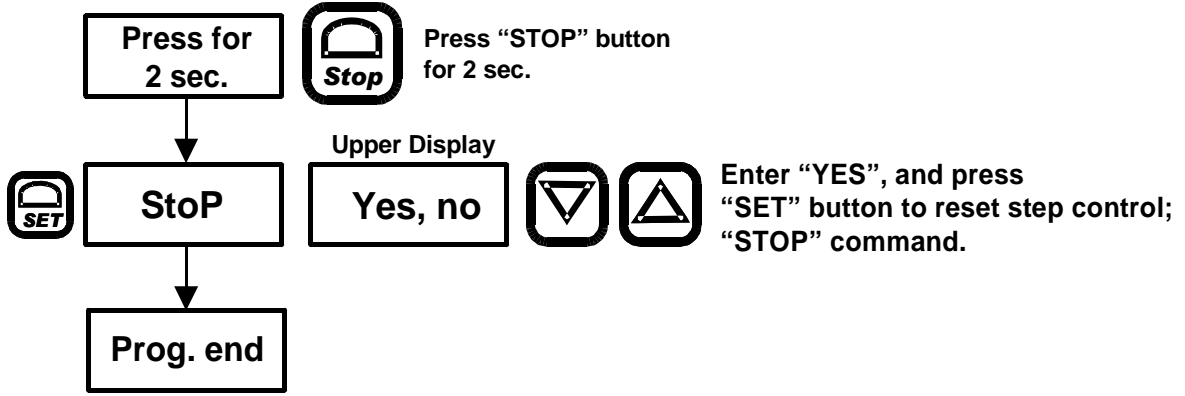

PAUSING STEP CONTROL TEMPORARILY; "PAUSE" COMMAND

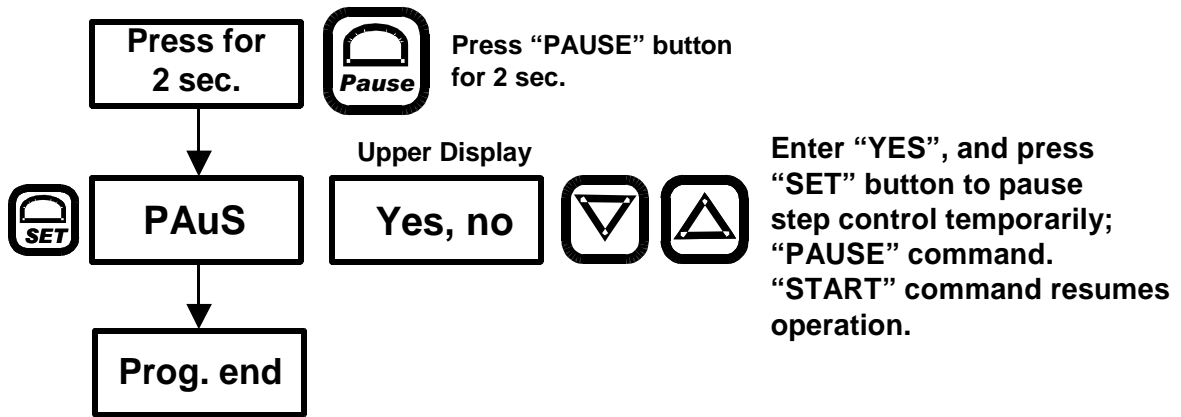

STARTING AUTO-TUNING

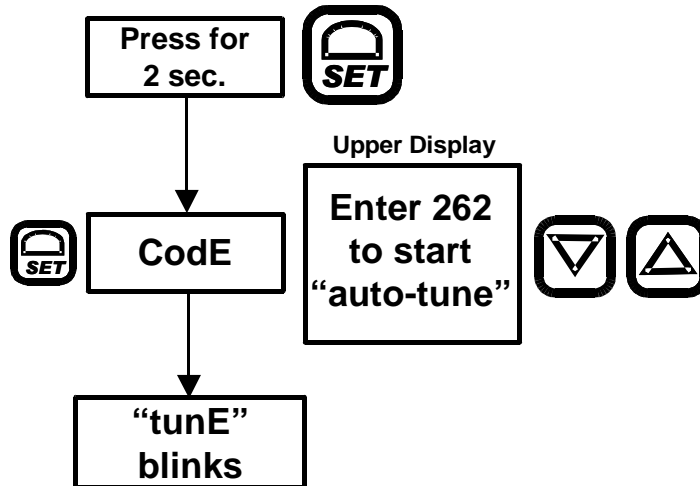

- Before starting Auto-tune, adjust "°C. 0" (refer to programming SET values).
- Process value may exceed "°C. 0" during auto-tuning.
- After auto-tuning, control form automatically switches to PID mode.
- Auto-tuning is stopped (interrupted) any time by pressing any key. In this case, the parameters before auto-tuning is valid.
- "STOP" command is executed prior to Auto-tuning. "START" command is required to restart step control after auto-tuning.
- Auto-tuning may not always determine the best values for your process.

ALARM OUTPUT

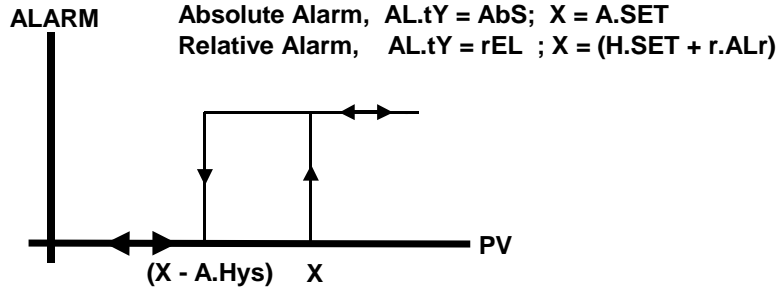

OUT OUTPUT (ON-OFF CONTROL)

- ON-OFF is active when “H.Hys” is other then 0

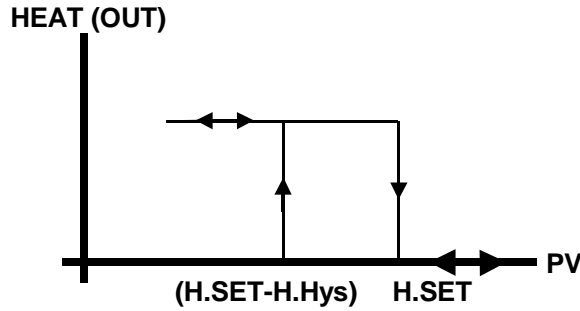

PID PARAMETERS

- **P, PI, PD, PID** is active when “H.Hys” is set to 0 (only for heating; h-C is set to “HEAt”)
- **PbC:** Proportional band in °C.
- **Ct:** Control period for PID control. Prefer 4-10 sec.
- **Ti:** Integral time; Set in minutes. Determines how fast controller reacts to compensate the offset between SET point and the process value. If set to 0, integral part is OFF. If set too low, process value may oscillate.
- **Td:** Derivative time; Set in minutes. If set to 0, derivative part is OFF. Determines how sensitive the controller is to changes of the offset between SET point and the process value. If set too high, process value may oscillate or overshoot.

STEP CONTROL PRINCIPLE

- Step control is done by adjusting SET value against time according to user configurable SET and time parameters. Device controls OUT output to equate process value (PV) to calculated SET value. Adjustment of SET value is independent of PV.
- There exists 3 commands for step control;
 - **1. START:** Starts step control from the initial SET value (“OC. 0”) if in “STOP” state. Resumes step control if in “PAUSE” state.
 - **2. STOP:** Step control is reset with “STOP” command and returns to initial SET value (“OC. 0”).
 - **3. PAUSE:** Step control is paused temporarily by the user. “START” command resumes operation.
- User may enter maximum 21 SET and 20 timer values to establish a profile. Number of steps is determined by user programmable “StEP” parameter.

STEP CONTROL PRINCIPLE (continued)

- If step control reaches to the end of last step, "End" message is displayed, meaning a successful ending of profile. "Successful Ending" means that no "STOP" command has been executed and/or no unrecoverable power failure has happened after a "START" command is executed. "Successful Ending" does not mean or does not guarantee that process value (PV) successfully followed SET value. User is responsible to watch the process to guarantee that PV has satisfactorily followed SET value. Device only adjusts SET value and controls OUT output, but does not wait for PV to reach to SET value before adjusting new SET value.
- If "STOP" message is displayed after a "START" command is executed, this means that the step control is unsuccessful or interrupted. Interruption may be a "STOP" command execution or an unrecoverable power failure situation.

POWER FAILURE SITUATION

- Device may detect power failure and saves current step no and remaining time for current stop no values to its EEPROM. It loads saved values upon power on.
- Device calculates the SET value for restored values and;
 - 1. If; $PV < (SET - C.P.on)$; "STOP" is executed. "STOP" message is displayed, step control is unsuccessful.
 - 2. If; $PV \geq (SET - C.P.on)$, step control is paused until $PV \geq (SET - 3)$, and then operation is resumed.
- (PV: process value / measured value, C.P.on: refer to programming system parameters)
- "C.P.on" is set by the user. User determines how device should behave in case of a power failure.

SAMPLE PROFILES

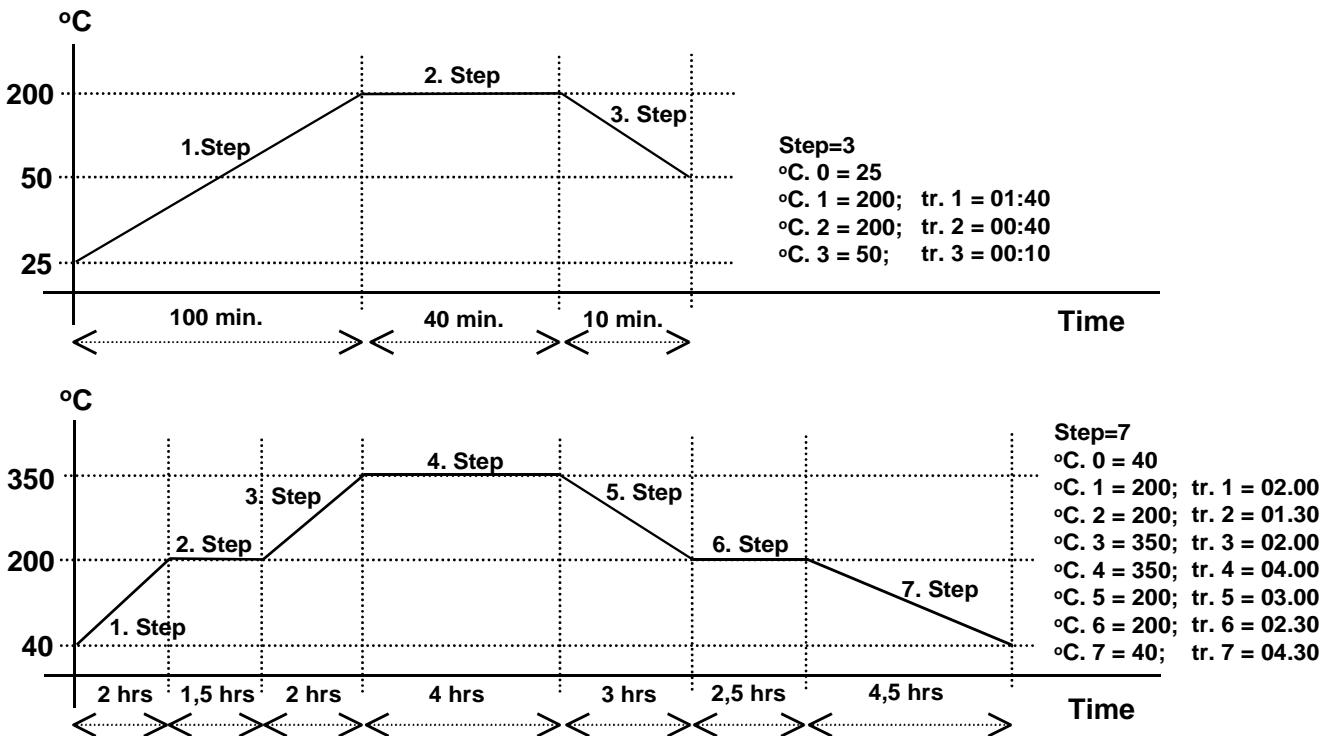

CLALEANING



Do not use any solvents (alcohol, thinners, benzine, acid, etc.) or corrosive substances to clean the device. Use only a dry and clean non-abrasive cloth. Before cleaning, disconnect the power supply and mains connections.